



SPECIFICATIONS

Overall Dimensions	59.5" W x 20.45" D(front to back) x 21.95" H
Counter Dimensions	59.5" W x 20.45" D(front to back) x 1.5" H
Sink Dimensions	21.5" W x 12.75" D(front to back) x 5" H
Drain Hole	1-1/2" diameter
Faucet Hole	1-3/8" diameter
Faucet Configurations	Single hole drilling

All measurements are approximate.

59.5" TN-A1510

Wall Hung Double Vanity Cabinet

Vanity Front

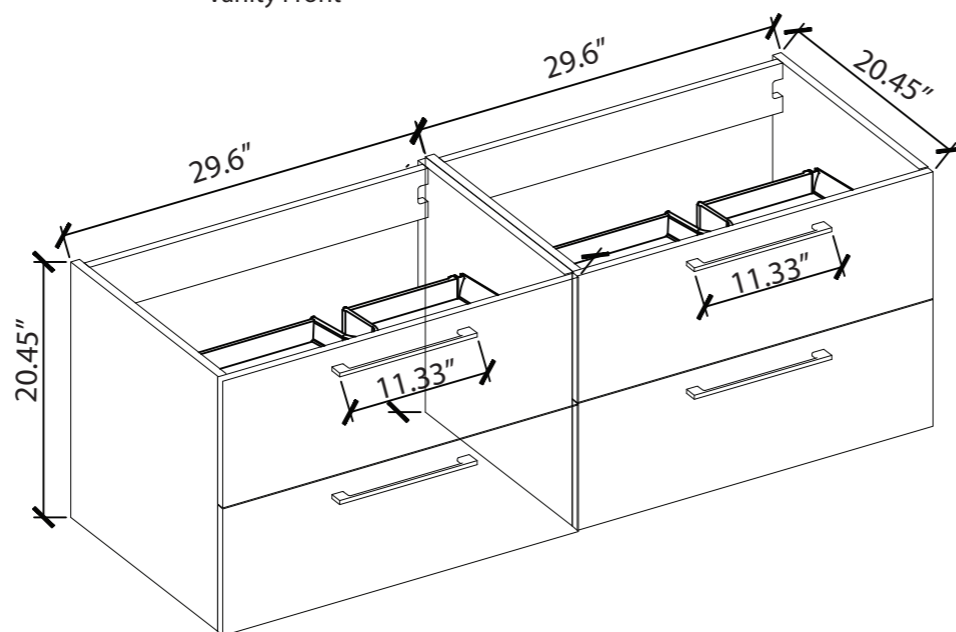

Vanity Side

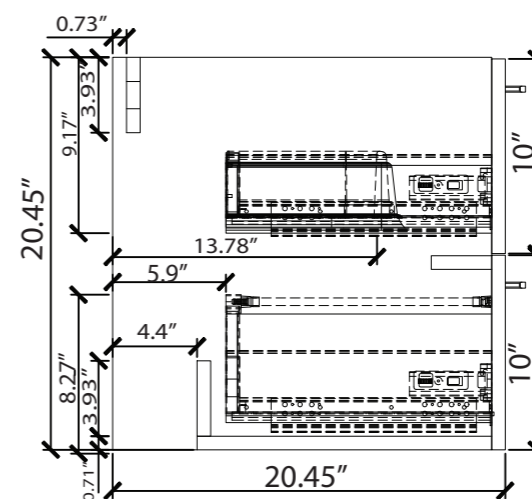

Vanity Top

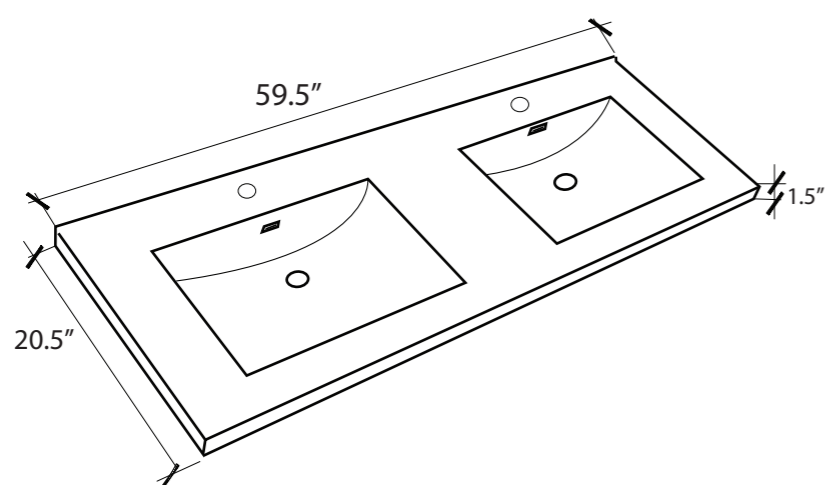

Vanity Back

